

LED FLOOD LIGHT



WARNING

PLEASE READ ALL INSTRUCTIONS BEFORE ATTEMPTING INSTALLATION

- To prevent personal injury or product damage only licensed electricians should install.
- To avoid electric shock or component damage disconnect power before attempting installation or servicing.
- This product must be installed in accordance with the national electric code (NEC) and all applicable federal, state and local electric codes and safety standards.
- Disconnect product and allow cooling prior to servicing.
- Any alteration or modification of this product is expressly forbidden as it may cause serious personal injury, death, property damage and/or product malfunction.
- To prevent product malfunction and/or electrical shock this product must be properly grounded.
- This luminaire is designed to operate in ambient temperatures ranging from -40°C to 45°C and to be horizontally mounted with the LEDs facing down.
- This product must be installed in accordance with the applicable installation code by a Person familiar with the construction and operation of the product and the hazards involved.
- MIN 75°C SUPPLY CONDUCTORS
- CONSULT A QUALIFIED ELECTRICIAN TO ENSURE CORRECT BRANCH CIRCUIT CONDUCTOR
- CAUTION - RISK OF FIRE
- Slipfitter Mounted with PHOTOCELL function elevation angle should not exceed 15 degrees

Installation Guide

Slipfitter

1. Connect the wires to L / N / GND
2. Remove the cover and adjust the bracket to the desired angle
3. Install the bracket on the pole and fix it with screws

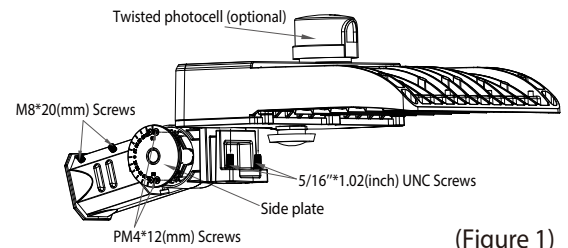

(Figure 1)

Wall Mount

1. Remove the side plate by loosen the screws.
2. Fix the back plate onto the arm bracket with screws provided.
3. Use the metal template provided to locate footprint on the wall to drill the holes, then fix the bracket on the wall with screws.
4. Route the power cord into wall mount bracket, slide the fixture onto the mounting bracket, then tighten bottom screws.
5. Make wiring connection inside of bracket and replace the side plate with screws.

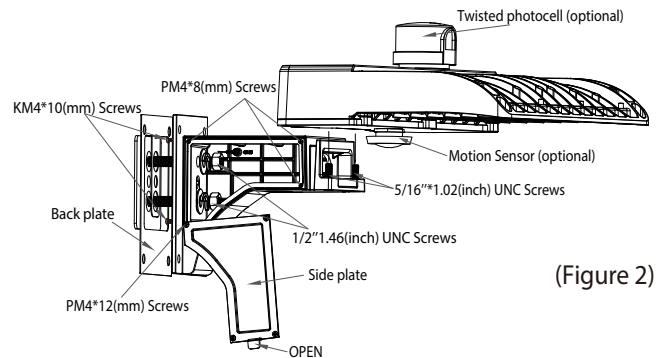

(Figure 2)

Yoke

1. Mount fixture onto surface using the hole pattern provided on the trunnion bracket.
2. Loosen center bolts and set screw.
3. Rotate fixture to desired aiming position and tighten center bolts.
4. Make wiring connection as per wire diagram below.

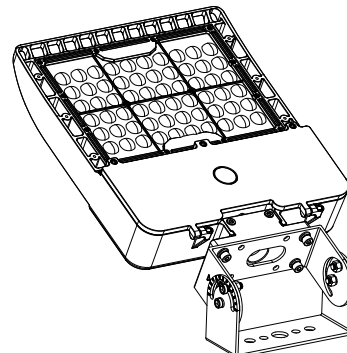

(Figure 3)

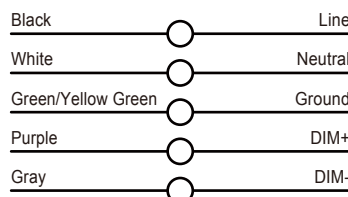
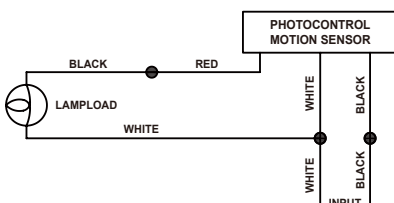
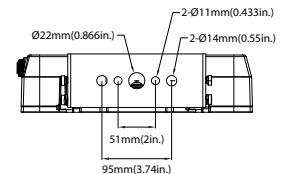

ACCESSORY LIST

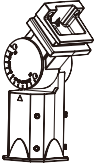
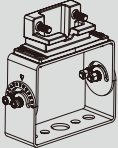
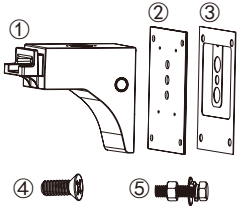
Mounting Type	Accessory	Specifications	Quantity
 Slipfitter Mount	Slipfitter	Adjustable slipfitter	1
 Yoke Mount	Bracket	L179.5W73H104T4 upper bracket + L188W73H104T4 lower bracket + L154W48H70 bracket	1
 Wall mount	① Pole Mout Arm	19.9 x 17.7 x 9cm Square pole mount arm	1
	② Wall Mount Plate	20.3 x 15.2 x 0.5cm Steel Plate	1
	③ Wall Mount Template	20.3 x 15.2 x 0.1cm Aluminum alloy plate	1
	④ Bolt	KM4 x 10" Stainless Steel flat head bolt	4
	⑤ Bolt	# 1/2" x 1.46" Stainless Steel Hexagon head bolt	2
Others	Twist-lock photocell	120-277V 3-Pin	1
	Receptacle	3-Pin receptacle	1
	Bolt	PM4 x 8 Stainless Steel, Round Flat bottom Bolt	2
	Occupancy Sensor	120-277V 0-10V Bi-level	1