



**MEDIUM SIZE:**  
100W / 140W / 180W



**LARGE SIZE:**  
250W / 300W / 400W

## Product Overview

Series GKOALG8 Area Lights offer a versatile area lighting solution for complicated projects. Power & CCT adjustment controls are standard on every model, with optional motion sensors and photocells available for additional control over light output. Optional backlight and full glare shields minimize lighting spillover to comply with local ordinances.



## Key Features

### CONSTRUCTION:

- Rugged single-piece, die-cast aluminum housing with integral heat sink fins.
- Housing has direct contact with the driver to help maintain low temperature and long lifespan.
- 3G vibration rated for areas with traffic, meeting ANSI standards C136.31.
- Housing is completely sealed against moisture and environmental contaminants.

### OPTICS:

- Type II (special order), III, IV, V light distribution available.
- Light engines are available in standard 3000K, 4000K and 5000K configurations.
- A wide range of lumen options available from 6,600 to 60,000 Lumens, replaces up to 1,000W metal halide.
- Impact and UV-resistant polycarbonate lens is precisely designed to give a specific light distribution, maximizing efficiency and application spacing.
- Optional backlight and full glare shield and backlight control grate are available for minimizing lighting spillover in order to comply with local ordinances.

### ELECTRICAL:

- Universal 120-277V or 347-480V input voltage.
- Minimum 10KA surge protection for 120-277V and 20KA surge protection for 347-480V included by default.
- 0-10V dimming driver(s) as default.
- THD: ≤20%, Power Factor: ≥90%.

### CONTROLS:

- Power & CCT adjustment controls standard, enabling power adjustment to 100%, 80%, 60%, or 40%, and CCT adjustment to 3000K, 4000K, and 5000K. 400W model is adjustable to 400W, 360W, 320W, or 300W and to 4000K and 5000K.
- Optional multi-level motion sensor - BRI823.
- Optional plug & play multi-level motion sensor - ANT-6-4T (by special order only).
- Optional twist-lock photocell - PO 120-277V, P3 347V, or P4 480V (by special order only).

### INSTALLATION:

- Suitable for mounting heights ranging from 26'-50' in area lighting applications.
- Fixed and adjustable round and square pole, slipfitter, yoke, and wall mount are available.
- Designed to be suitable for installation by only one person.

### WARRANTY:

- 5 Year Limited Warranty.

### LISTINGS:

- DesignLights Consortium® (DLC) Premium qualified.
- UL listed for wet locations.
- Rated for ambient operating temperature -40°F to 113°F (-40°C to 45°C). 400W is rated for -40°F to 104°F (-40°C to 40°C).

# Performance Data

## Lumen Output

100W									
Setting	System Watts	Distribution Type	CRI	3000K		4000K		5000K	
				Lumens	Efficacy	Lumens	Efficacy	Lumens	Efficacy
100%	100W	2	70	14500lm	145lm/W	15800lm	158lm/W	15000lm	150lm/W
		3	70	14500lm	145lm/W	15800lm	158lm/W	15000lm	150lm/W
		4	70	14500lm	145lm/W	15800lm	158lm/W	15000lm	150lm/W
		5	70	15100lm	151lm/W	16000lm	160lm/W	15600lm	156lm/W
80%	80W	2	70	12000lm	150lm/W	13000lm	163lm/W	12500lm	156lm/W
		3	70	12000lm	150lm/W	13000lm	163lm/W	12500lm	156lm/W
		4	70	12000lm	150lm/W	13000lm	163lm/W	12500lm	156lm/W
60%	60W	5	70	12500lm	156lm/W	13300lm	166lm/W	12800lm	160lm/W
		2	70	9300lm	155lm/W	10000lm	167lm/W	9600lm	160lm/W
		3	70	9300lm	155lm/W	10000lm	167lm/W	9600lm	160lm/W
		4	70	9300lm	155lm/W	10000lm	167lm/W	9600lm	160lm/W
40%	40W	5	70	9600lm	160lm/W	10200lm	170lm/W	9850lm	164lm/W
		2	70	6400lm	160lm/W	6800lm	170lm/W	6560lm	164lm/W
		3	70	6400lm	160lm/W	6800lm	170lm/W	6560lm	164lm/W
		4	70	6400lm	160lm/W	6800lm	170lm/W	6560lm	164lm/W
		5	70	6560lm	164lm/W	7000lm	175lm/W	6700lm	168lm/W

140W									
Setting	System Watts	Distribution Type	CRI	3000K		4000K		5000K	
				Lumens	Efficacy	Lumens	Efficacy	Lumens	Efficacy
100%	140W	2	70	20000lm	143lm/W	23000lm	164lm/W	21000lm	150lm/W
		3	70	20000lm	143lm/W	23000lm	164lm/W	21000lm	150lm/W
		4	70	20000lm	143lm/W	23000lm	164lm/W	21000lm	150lm/W
		5	70	21000lm	150lm/W	23500lm	168lm/W	21500lm	154lm/W
80%	120W	2	70	18000lm	150lm/W	20000lm	167lm/W	18500lm	154lm/W
		3	70	18000lm	150lm/W	20000lm	167lm/W	18500lm	154lm/W
		4	70	18000lm	150lm/W	20000lm	167lm/W	18500lm	154lm/W
60%	90W	5	70	18500lm	154lm/W	20500lm	171lm/W	19000lm	158lm/W
		2	70	13800lm	153lm/W	15200lm	169lm/W	14200lm	158lm/W
		3	70	13800lm	153lm/W	15200lm	169lm/W	14200lm	158lm/W
		4	70	13800lm	153lm/W	15200lm	169lm/W	14200lm	158lm/W
40%	60W	5	70	14000lm	156lm/W	15600lm	172lm/W	14500lm	161lm/W
		2	70	9400lm	157lm/W	10300lm	172lm/W	9700lm	162lm/W
		3	70	9400lm	157lm/W	10300lm	172lm/W	9700lm	162lm/W
		4	70	9400lm	157lm/W	10300lm	172lm/W	9700lm	162lm/W
		5	70	9600lm	160lm/W	10500lm	175lm/W	10000lm	167lm/W

180W									
Setting	System Watts	Distribution Type	CRI	3000K		4000K		5000K	
				Lumens	Efficacy	Lumens	Efficacy	Lumens	Efficacy
100%	180W	2	70	24800lm	138lm/W	27000lm	150lm/W	25200lm	140lm/W
		3	70	24000lm	133lm/W	27000lm	150lm/W	25200lm	140lm/W
		4	70	24800lm	138lm/W	27000lm	150lm/W	25200lm	140lm/W
		5	70	25500lm	142lm/W	28000lm	156lm/W	26000lm	144lm/W
80%	144W	2	70	20200lm	140lm/W	22000lm	153lm/W	20600lm	143lm/W
		3	70	20200lm	140lm/W	22000lm	153lm/W	20600lm	143lm/W
		4	70	20200lm	140lm/W	22000lm	153lm/W	20600lm	143lm/W
60%	108W	5	70	20800lm	144lm/W	22800lm	158lm/W	21000lm	146lm/W
		2	70	15300lm	142lm/W	16800lm	156lm/W	15700lm	145lm/W
		3	70	15300lm	142lm/W	16800lm	156lm/W	15700lm	145lm/W
		4	70	15300lm	142lm/W	16800lm	156lm/W	15700lm	145lm/W
40%	72W	5	70	15800lm	146lm/W	17300lm	160lm/W	16200lm	150lm/W
		2	70	10500lm	146lm/W	11500lm	160lm/W	10800lm	150lm/W
		3	70	10500lm	146lm/W	11500lm	160lm/W	10800lm	150lm/W
		4	70	10500lm	146lm/W	11500lm	160lm/W	10800lm	150lm/W
		5	70	10800lm	150lm/W	11800lm	164lm/W	11000lm	153lm/W

250W									
Setting	System Watts	Distribution Type	CRI	3000K		4000K		5000K	
				Lumens	Efficacy	Lumens	Efficacy	Lumens	Efficacy
100%	250W	2	70	33500lm	134lm/W	37000lm	148lm/W	34500lm	138lm/W
		3	70	33500lm	134lm/W	37000lm	148lm/W	34500lm	138lm/W
		4	70	33500lm	134lm/W	37000lm	148lm/W	34500lm	138lm/W
		5	70	34500lm	138lm/W	38000lm	152lm/W	35500lm	142lm/W
80%	200W	2	70	27500lm	138lm/W	30400lm	152lm/W	28400lm	142lm/W
		3	70	27500lm	138lm/W	30400lm	152lm/W	28400lm	142lm/W
		4	70	27500lm	138lm/W	30400lm	152lm/W	28400lm	142lm/W
		5	70	28000lm	140lm/W	31000lm	155lm/W	28800lm	144lm/W
60%	150W	2	70	21300lm	142lm/W	23200lm	155lm/W	21800lm	145lm/W
		3	70	21300lm	142lm/W	23200lm	155lm/W	21800lm	145lm/W
		4	70	21300lm	142lm/W	23200lm	155lm/W	21800lm	145lm/W
		5	70	21800lm	145lm/W	23800lm	159lm/W	22500lm	150lm/W
40%	100W	2	70	14500lm	145lm/W	16000lm	160lm/W	14800lm	148lm/W
		3	70	14500lm	145lm/W	16000lm	160lm/W	14800lm	148lm/W
		4	70	14500lm	145lm/W	16000lm	160lm/W	14800lm	148lm/W
		5	70	15000lm	150lm/W	16500lm	165lm/W	15500lm	155lm/W

300W									
Setting	System Watts	Distribution Type	CRI	3000K		4000K		5000K	
				Lumens	Efficacy	Lumens	Efficacy	Lumens	Efficacy
100%	300W	2	70	41000lm	137lm/W	45000lm	150lm/W	42000lm	140lm/W
		3	70	41000lm	137lm/W	45000lm	150lm/W	42000lm	140lm/W
		4	70	41000lm	137lm/W	45000lm	150lm/W	42000lm	140lm/W
		5	70	42500lm	142lm/W	46000lm	153lm/W	43500lm	145lm/W
80%	240W	2	70	33600lm	140lm/W	37000lm	154lm/W	34500lm	144lm/W
		3	70	33600lm	140lm/W	37000lm	154lm/W	34500lm	144lm/W
		4	70	33600lm	140lm/W	37000lm	154lm/W	34500lm	144lm/W
		5	70	34500lm	144lm/W	38000lm	158lm/W	35500lm	148lm/W
60%	180W	2	70	26000lm	144lm/W	28600lm	159lm/W	26600lm	148lm/W
		3	70	26000lm	144lm/W	28600lm	159lm/W	26600lm	148lm/W
		4	70	26000lm	144lm/W	28600lm	159lm/W	26600lm	148lm/W
		5	70	26600lm	148lm/W	29700lm	165lm/W	27500lm	153lm/W
40%	120W	2	70	18000lm	150lm/W	20000lm	167lm/W	18500lm	154lm/W
		3	70	18000lm	150lm/W	20000lm	167lm/W	18500lm	154lm/W
		4	70	18000lm	150lm/W	20000lm	167lm/W	18500lm	154lm/W
		5	70	18500lm	154lm/W	20800lm	173lm/W	19000lm	158lm/W

400W							
Setting	System Watts	Distribution Type	CRI	4000K		5000K	
				Lumens	Efficacy	Lumens	Efficacy
LV1	400W	2	70	60500lm	151lm/W	61000lm	153lm/W
		3	70	60500lm	151lm/W	61500lm	154lm/W
		4	70	60500lm	151lm/W	61000lm	153lm/W
		5	70	61000lm	153lm/W	63000lm	158lm/W
LV2	360W	2	70	56000lm	156lm/W	55000lm	153lm/W
		3	70	56000lm	156lm/W	55000lm	153lm/W
		4	70	56000lm	156lm/W	55000lm	153lm/W
		5	70	51000lm	157lm/W	55500lm	154lm/W
LV3	320W	2	70	51000lm	159lm/W	50000lm	156lm/W
		3	70	51000lm	159lm/W	50000lm	156lm/W
		4	70	51000lm	159lm/W	50000lm	156lm/W
		5	70	51500lm	161lm/W	50500lm	159lm/W
LV4	300W	2	70	47000lm	162lm/W	46000lm	159lm/W
		3	70	47000lm	162lm/W	46000lm	159lm/W
		4	70	47000lm	162lm/W	46000lm	159lm/W
		5	70	47500lm	164lm/W	46500lm	160lm/W

Note: On all wattages except 400W, power adjustment controls may be set to 100%, 80%, 60%, or 40%, whereas on 400W, power adjustment controls are set to LV1 (400W), LV2 (360W), LV3 (320W), or LV4 (300W).



100 E. Crossroads Pkwy. Ste. C  
 Bolingbrook, IL 60440  
 Phone: 630-793-9449  
 Web: www.gkoled.com

## BUG Rating at 5000K

System Watts	Voltage	Distribution Type	B	U	G
100W	120-277V/347-480V	2	3	0	3
		3	3	0	3
		4	3	0	2
		5	4	0	2
140W	120-277V/347-480V	2	3	0	3
		3	3	0	3
		4	3	0	3
		5	4	0	2
180W	120-277V/347-480V	2	4	0	3
		3	3	0	3
		4	3	0	3
		5	4	0	2
250W	120-277V/347-480V	2	4	0	4
		3	4	0	4
		4	4	0	3
		5	5	0	3
300W	120-277V/347-480V	2	5	0	4
		3	4	0	4
		4	4	0	4
		5	5	0	4
400W	120-277V/347-480V	2	5	0	4
		3	5	0	5
		4	5	0	5
		5	5	0	4

## EPA of Area Light

	1	2 @90°	2 @120°	2 @180°	3 @90°	3 @120°	4 @90°
100W/140W/180W	0.3632	0.6849	0.8861	0.7264	1.0481	1.2078	1.0481
250W/300W/400W	0.4758	0.8091	1.059	0.9516	1.2849	1.3923	1.2849

## Electrical Data

Number Of Drivers	Driver Current (mA)	Nominal Power (W)	Input Voltage (V)	Current (Amps)
1	850	100	120	0.83
		100	208	0.48
		100	240	0.42
		100	277	0.36
	2520	100	347	0.29
		100	480	0.21
1	1200	140	120	1.17
		140	208	0.67
		140	240	0.58
		140	277	0.51
		140	347	0.40
		140	480	0.29
1	960	180	120	1.50
		180	208	0.87
		180	240	0.75
		180	277	0.65
		180	347	0.52
		180	480	0.38

Number Of Drivers	Driver Current (mA)	Nominal Power (W)	Input Voltage (V)	Current (Amps)
1	1200	250	120	2.08
		250	208	1.20
		250	240	1.04
		250	277	0.90
		250	347	0.72
1	1500	300	120	2.50
		300	208	1.44
		300	240	1.25
		300	277	1.08
		300	347	0.86
1	1460	400	120	3.33
		400	208	1.92
		400	240	1.67
		400	277	1.44
		400	347	1.15
		400	480	0.83

## Lighting Distribution

GKOLED offers a complete set of optical systems to meet every site lighting requirement. These systems provide remarkable flexibility in precisely matching light distribution patterns to specific site requirements.

Type 2 optics are ideal for applications where there is a need to space the luminaires farther apart along a road or pathway. The light distribution pattern is optimized for elongated areas, allowing for greater pole spacing without sacrificing lighting quality.

Type 3 optics produce an asymmetrical pattern that directs the majority of the light forward and equally on both sides of the luminaire. In a back to back configuration, it creates a rectangular pattern which can extend pole spacings.

Type 4 is suitable for applications where light is primarily required forward with minimal backlight. Typical installations include perimeter poles.

Type 5 optics produce a symmetrical square distribution pattern that distributes light equally on all sides of the luminaire. Type 5 luminaires are universal for most area lighting applications.

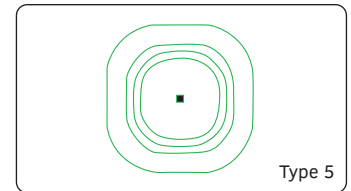
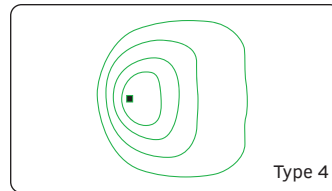
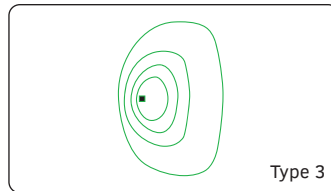
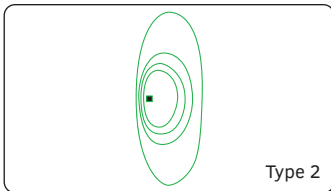

## Dimensions & Weight

100W/140W/180W  
(Adjustable Pole Mount)

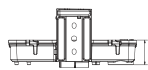
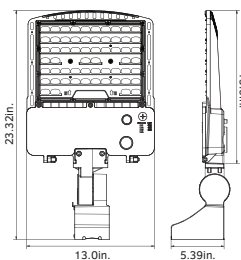

Net Weight  
100W: 9.87lb.  
140W: 10.38lb.  
180W: 10.6lb.

100W/140W/180W  
(Slipfitter Mount)

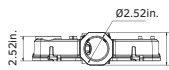
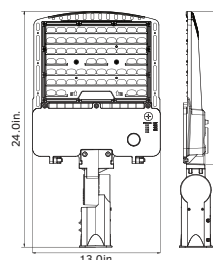

Net Weight  
100W: 10.29lb.  
140W: 10.81lb.  
180W: 11.02lb.

100W/140W/180W  
(Wall Mount)

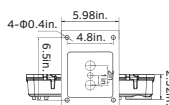
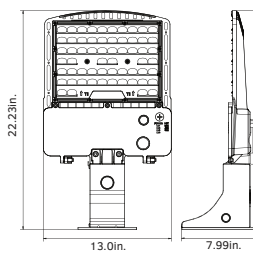

Net Weight  
100W: 12.81lb.  
140W: 13.32lb.  
180W: 13.53lb.

100W/140W/180W  
(Pole Mount)

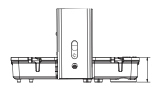
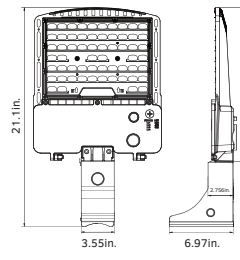

Net Weight  
100W: 10.56lb.  
140W: 11.07lb.  
180W: 11.28lb.

100W/140W/180W  
(Yoke Mount)

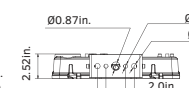
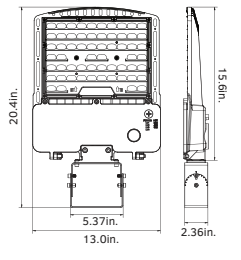

Net Weight  
100W: 9.06lb.  
140W: 9.57lb.  
180W: 9.78lb.

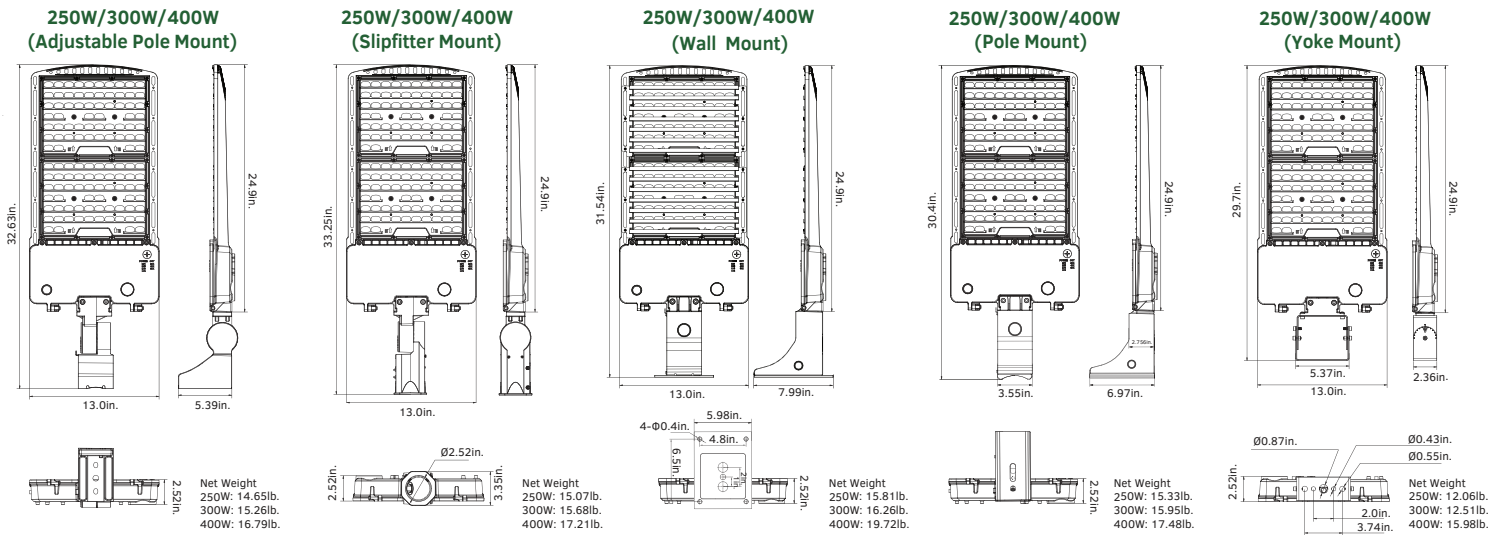

## Mounting Information

### Mounting Options



**Pole Mount (4" and 5" Square and Round Poles)**

Standard versatile mounting arm is simple to install and can be used with existing poles for retrofit installations.

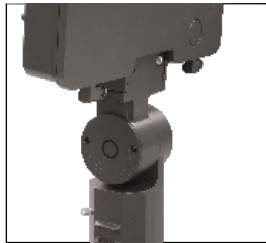

**Slipfitter Mount**

An optional cast aluminum mast arm adaptor secures fixture head to nominal 2" (2-3/8" O.D. pipe size) horizontal steel tenon arm.



**Wall Mount**

An optional cast aluminum mast arm adaptor secures fixture head to nominal 2" (2-3/8" O.D. pipe size) horizontal steel tenon arm.



**Yoke Mount**

Die-cast aluminum yoke is easily adapted to many surfaces and adjusted to a range of fixture aiming angles.

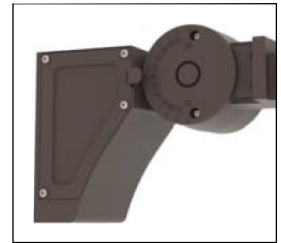

**Adjustable Pole Mount**

Adjustable mounting arm is simple to install and can be used with existing poles for retrofit installations.

### Mounting Accessories

Round Pole Connecting Plate • For square mount to be fixed to a round pole

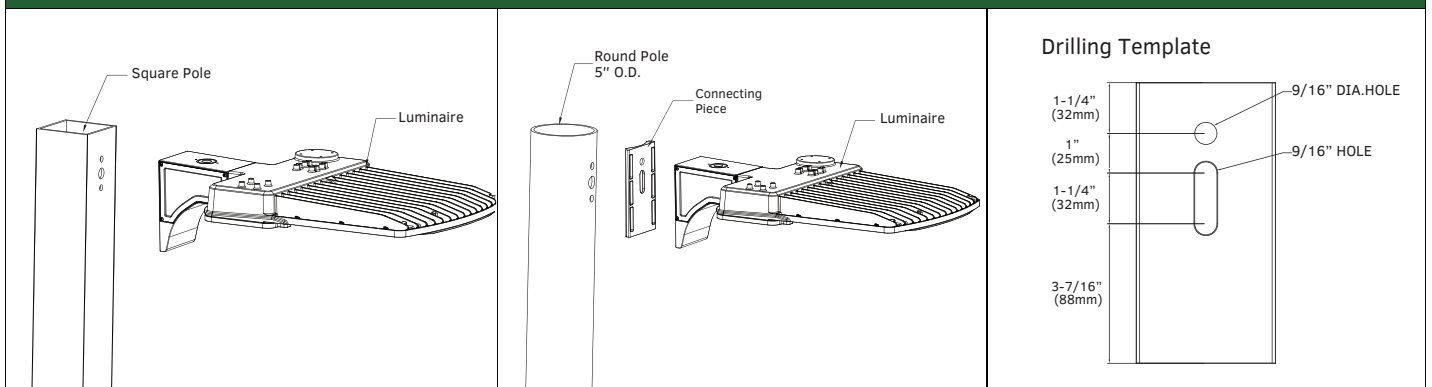



# Additional Accessories

POLE BRACKET • For mounting one fixture on an existing pole			
	<p>4" Square Pole Mount with 2-3/8" O.D. Tenon NO. 4SQ-SP-D FINISH: Dark Bronze USE: For use with square, non-tapered steel and aluminum poles. Furnished with four 5/16" hex head stainless-steel bolts. Vertical tenon measures 2-3/8" O.D., and is made of steel tubing. Fixtures mounted to this bracket can be adjusted both vertically and horizontally.</p>		<p>4" Round Pole Mount with 2-3/8" O.D. Tenon NO. 4SQR-SP-D FINISH: Dark Bronze USE: For use with round, non-tapered steel and aluminum poles. Furnished with three 3/8" hex head stainless-steel bolts. Vertical tenon measures 2-3/8" O.D., and is made of steel tubing. Fixtures mounted to this bracket can be adjusted both vertically and horizontally.</p>
	<p>5" Square Pole Mount with 2-3/8" O.D. Tenon NO. 5SQ-SP-D FINISH: Dark Bronze USE: For use with square, non-tapered steel and aluminum poles. Furnished with four 5/16" hex head stainless-steel bolts. Vertical tenon measures 2-3/8" O.D., and is made of steel tubing. Fixtures mounted to this bracket can be adjusted both vertically and horizontally.</p>		<p>5" Round Pole Mount with 2-3/8" O.D. Tenon NO. 5SQR-SP-D FINISH: Dark Bronze USE: For use with round, non-tapered steel and aluminum poles. Furnished with three 3/8" hex head stainless-steel bolts. Vertical tenon measures 2-3/8" O.D., and is made of steel tubing. Fixtures mounted to this bracket can be adjusted both vertically and horizontally.</p>
	<p>2-3/8" O.D. Tenon Mount Adaptor for Yoke Fixtures NO. SP-TR-D FINISH: Dark Bronze USE: The 2-3/8" O.D. Tenon Mount Adaptor for Yoke Fixtures is designed to mount GKOLED light fixtures that are equipped with a yoke mount onto a 2-3/8" O.D. tenon. It may be utilized with the GKOLED flood light series of light fixture.</p>		<p>Angle Adjustment Adaptor NO. SQA-ALD4DA FINISH: Dark Bronze USE: This durable bracket is engineered as a versatile mounting option. Made from die-cast aluminum, it allows for optimal positioning of the light fixture to maximize the light effectiveness both vertically and horizontally.</p>
	<p>Horizontal Wall or Square or Round Pole Mount with 2-3/8" O.D. Tenon Bracket NO. SQ/R-SP-D FINISH: Dark Bronze USE: This tenon bracket can be installed onto a wall, square pole, or round pole. Provides wiring access and a built-in 2-3/8" O.D. tenon to mount a fixture with our adjustable slipfitter. Suggested 3/8" diameter bolts for mounting.</p>		
WALL BRACKET • Provides wiring access		Mid-Pole Tenon Bracket	
	<p>90° Wall Mount Bracket with 2-3/8" O.D. Tenon NO. WM-SP-D FINISH: Dark Bronze USE: The 90° Wall Mount Bracket with 2-3/8" Tenon attaches a GKOLED flood light to almost any surface, wall, roof, or wood pole. Provides wiring access and a built-in 2-3/8" O.D. tenon to mount a fixture with our adjustable slipfitter. Suggested 3/8" diameter bolts for mounting. Mounting holes are spaced 3-1/4" apart.</p>		<p>2-3/8" O.D. Horizontal Tenon Mid-Pole Bracket NO. SQ-SP-D FINISH: Dark Bronze USE: The 2-3/8" O.D. Horizontal Tenon Mid-Pole Bracket is designed to mount a light fixture that is equipped with an adjustable slipfitter onto a 2-3/8" O.D. horizontal tenon.</p>
Round External Mount Horizontal Tenon • To mount 2, 3, or 4 fixtures on an existing pole			
	<p>Double 90° Horizontal Tenon Adaptor NO. R60-SP2-90-D FINISH: Dark Bronze USE: The Bracket is designed to mount over a 2-3/8" (60mm) O.D. vertical tenon. Two fixtures can be mounted to the Round External Mount Horizontal Tenon and adjusted horizontally.</p>		<p>Triple 120° Horizontal Tenon Adaptor NO. R60-SP3-120-D FINISH: Dark Bronze USE: The Bracket is designed to mount over a 2-3/8" (60mm) O.D. vertical tenon. Three fixtures can be mounted to the Round External Mount Horizontal Tenon and adjusted horizontally.</p>
	<p>Double 180° Horizontal Tenon Adaptor NO. R60-SP2-180-D FINISH: Dark Bronze USE: The Bracket is designed to mount over a 2-3/8" (60mm) O.D. vertical tenon. Two fixtures can be mounted to the Round External Mount Horizontal Tenon and adjusted horizontally.</p>		<p>Quad 90° Horizontal Tenon Adaptor NO. R60-SP4-90-D FINISH: Dark Bronze USE: The Bracket is designed to mount over a 2-3/8" (60mm) O.D. vertical tenon. Four fixtures can be mounted to the Round External Mount Horizontal Tenon and adjusted horizontally.</p>
	<p>Triple 90° Horizontal Tenon Adaptor NO. R60-SP3-90-D FINISH: Dark Bronze USE: The Bracket is designed to mount over a 2-3/8" (60mm) O.D. vertical tenon. Three fixtures can be mounted to the Round External Mount Horizontal Tenon and adjusted horizontally.</p>		

# Accessories



**MULTI-LEVEL MOTION SENSOR**  
Multi-level motion sensor detects occupancy in an area for additional energy savings.



**PLUG & PLAY MOTION SENSOR**  
Special order plug & play multi-level motion sensor detects occupancy in an area for additional energy savings.



**TWIST LOCK PHOTOCELL**  
Factory-installed twist-lock photocell adds dusk to dawn function for additional energy savings.

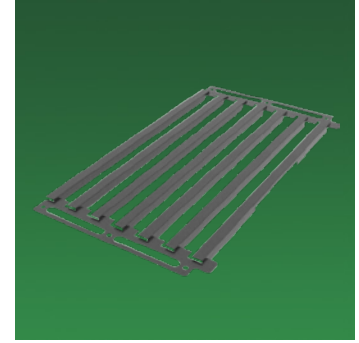

**BACKLIGHT CONTROL GRATE**  
Backlight control fits over the fixture lens to minimize light spillover and comply with local ordinances.

## Glare Shields

An optional backlight control provides reduced light spillover and increased visual comfort without compromising performance.

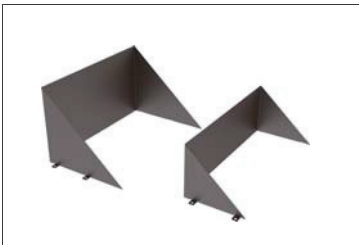

Backlight Glare Shield



Full Glare Shield

## Ordering Information

Area Light Series GKOALG8										Example: GKOALG8140W27VXXKYYYY	
Fixture Type	Wattage	Voltage	CCT	Finish	Photocell (Optional)	Sensor (Optional)	Mounting	Photometry	Power & CCT Adjustable		
GKOALG8	100W 140W 180W 250W 300W 400W	27V 120-277V 48V 347-480V	DDK Power & CCT Tunable	D Dark Bronze B Black W White SG Silver Gray	P0 120-277V Photocell P3 347V Photocell P4 480V Photocell Blank Without Photocell	M With Sensor Blank Without Sensor	SQ Square Pole Mount SP Slipfitter Mount WM Wall Mount YK Yoke Mount SQA Adjustable Pole Mount	T2 Type II T3 Type III T4 Type IV T5 Type V	AD With Adjustment Dial Blank Without Adjustment Dial	Blank Alphanumeric	

Note: Not all product variations listed on this page are DLC qualified. Visit [www.designlights.org](http://www.designlights.org) to confirm qualification.