

 **WARNING**

PLEASE READ ALL INSTRUCTIONS BEFORE ATTEMPTING INSTALLATION

- To prevent personal injury or product damage only licensed electricians should install.
- To avoid electric shock or component damage disconnect power before attempting installation or servicing.
- This product must be installed in accordance with the national electric code (NEC) and all applicable federal, state, and local electric codes and safety standards.
- Disconnect product and allow cooling prior to servicing.
- Any alteration or modification of this product is expressly forbidden as it may cause serious personal injury, death, property damage, and/or product malfunction.
- To prevent product malfunction and/or electrical shock this product must be properly grounded.
- This luminaire is designed to operate in ambient temperatures ranging from -40°F to 113 °F and to be horizontally mounted with the LEDs facing down.
- This product is not available for several special environments, such as places with corrosive gas liquids or gas stations.

Surface Mounting With J-Box

- Loosen and remove the M4 Screws used to attach the mounting plate to the fixture.

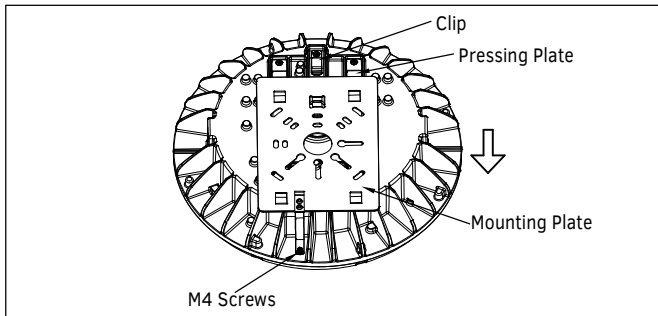

- Attach the mounting plate to the ceiling using M16 Expansion Bolts or M6 stainless steel screws with plastic anchors (not included).

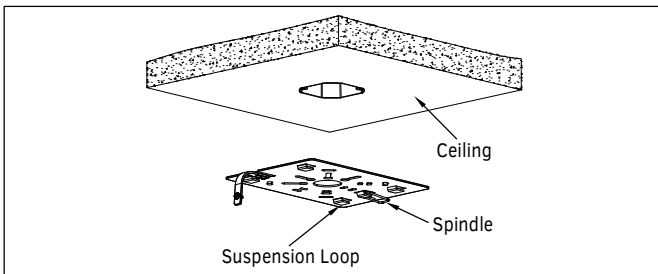

- Connect the clip of the fixture to the spindle of the mounting plate to ensure the fixture will not slip and fall. Complete wiring using the wiring diagram, then push the pressing plate into the suspension loop on the mounting plate.

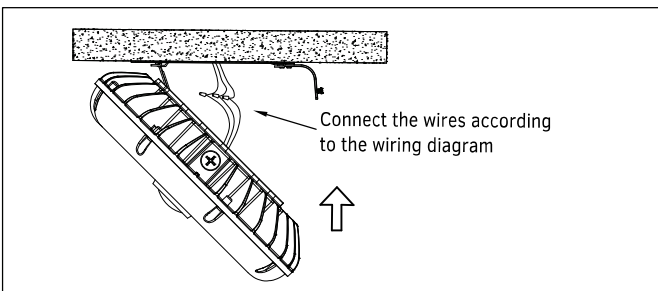

- Reattach the mounting plate to the fixture using the previously removed M4 Screws.

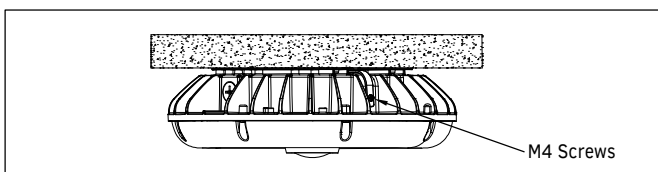

Pendant Mounting With 3/4 Inch Conduit

- Complete wiring using the wiring diagram.
- Screw the fixture onto the 3/4 inch conduit (not included) to complete the installation.

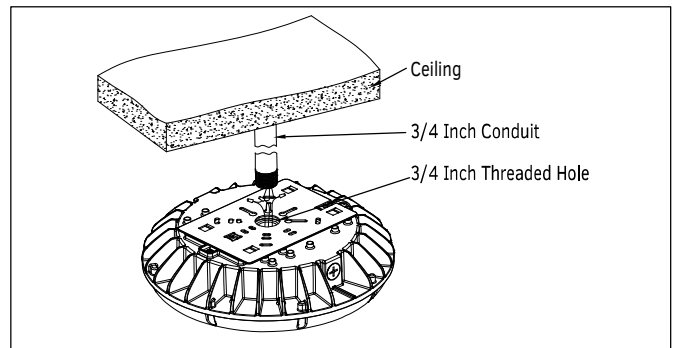

Power & CCT Adjustment Controls

Remove the screw plug on the side of the light, adjust the dial switch to the desired power level and color temperature to match the application requirements, then reinstall the screw plug as demonstrated below:

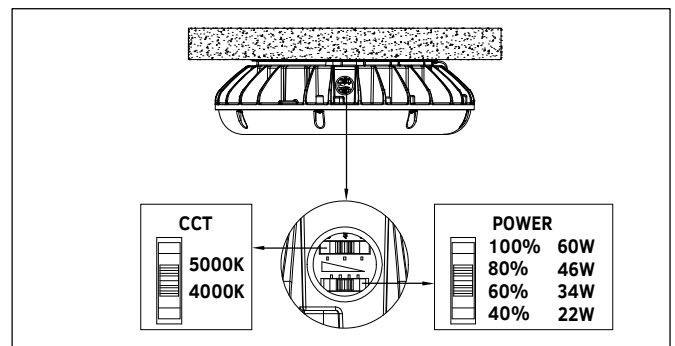

NOTE: Power values indicated in diagram are based on tested values and may slightly vary.

Wiring Diagram

WITHOUT EMERGENCY BATTERY

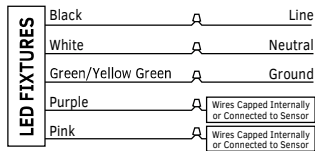

WITH EMERGENCY BATTERY

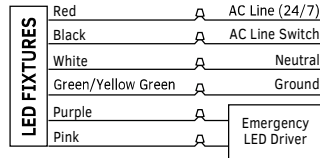

60W POWER & CCT TUNABLE

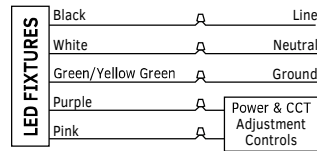

Note: Two dimming wires in the the driver box. On the fixed power & CCT model, dimming wires are capped internally and only usable with an optional motion sensor. When using an Emergency Battery Backup, dimming wires are connected to the Emergency LED Driver. In the 60W Power & CCT Tunable model, dimming wires are connected to the Power & CCT Adjustment Controls.

Optional - Multi-Level Motion Sensor (Fixed Wattage & CCT Models)

Motion Sensor Dimensions & Specifications (For Sensor Factory Settings, See Last Page)

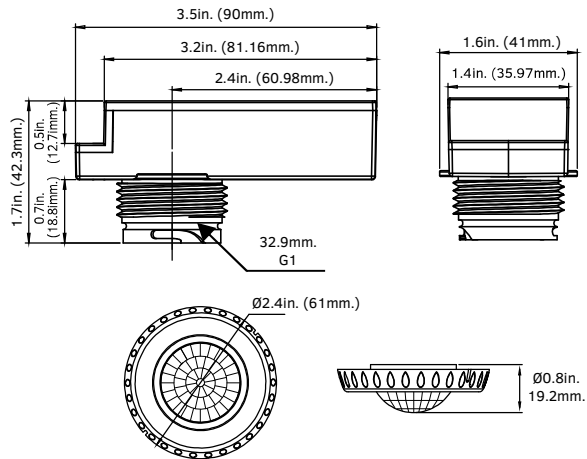

Specifications

- Power Supply:** 120/277VAC, 50/60Hz
- Dimming Control Output:** 0-10V, default 10V
- Detection Radius & Angle:** 30' @ 40' Mounting Height, 360°
- Mounting Height:** Max. 40'
- Humidity:** 20-90%
- Operating Temperature:** -40°F to 158°F (-40°C to 70°C)

Sensor Coverage

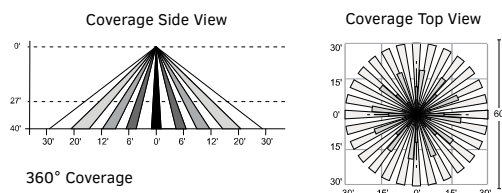

⚠ Important

- Sensor warm up time is 40 seconds. After the sensor connects to input power the first time, the light fixture will stay on for 40 seconds, then dim for normal operation.
- Factory Default Settings: Sensor Detection Range 100%, Sensor Hold Time 10 Seconds, Light Threshold 30 Lux, Stand-By Light Level 30%, Stand-By Time: 60 Minutes.
- When any setting is changed using the dip switches or remote control, the light fixture that the sensor is connected to will turn on and off to confirm the change.

Multi-Level Function

The motion sensor includes the capability for tri-level control functionality, for areas which require a preliminary notification consisting of a change in the brightness of the light before the light switches off completely. When the sensor is installed, there are 3 lighting modes: 100% --> dimmed (under reduced natural lighting conditions) --> off, with 2 periods of selectable waiting time: sensor hold time and sensor stand-by time. Additional configurable options include light threshold for sensor operation, and sensor sensitivity/detection area.



When natural lighting conditions are sufficient, the motion sensor does not turn on the fixture even when motion is detected.



When natural lighting conditions fall below a selected threshold, the motion sensor turns on the fixture when motion is detected.



After sensor hold time elapses, the motion sensor dims the fixture to the stand-by light level if the natural light conditions are below the selected threshold.



After the stand-by time period elapses, the motion sensor switches the fixture off automatically.

Daylight Sensor Function

Select the daylight sensor function by pushing **(II)** when the remote control is in setting mode.

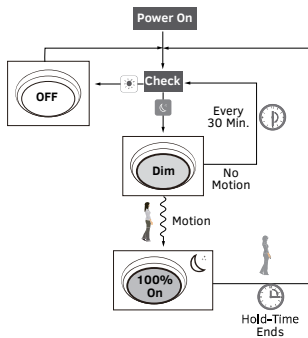

Settings In This Demonstration:

Hold-Time: 30 Minutes
 Setpoint On: 50 Lux
 Setpoint Off: 300 Lux
 Stand-By Dimming Level: 10%
 Stand-By Period: +∞

(The +∞ Stand-By Period option is only available when the Daylight Sensor is activated.)



When movement is detected, the light switches on to 100% brightness.



After sensor hold-time elapses, the light dims to the stand-by level.



The light remains dimmed to the stand-by level at night.

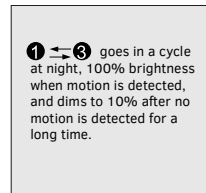

When the natural light level exceeds the "setpoint off" light level, the fixture will remain off even when the space is occupied.

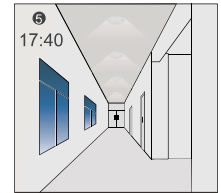

The light stays on at 10% brightness when motion is not detected and natural light conditions are insufficient.

Optional - Plug & Play Multi-Level Motion Sensor (60W Power & CCT Selectable Model)

Motion Sensor Dimensions & Specifications (Factory Settings May Be Changed Using Optional Remote Control)

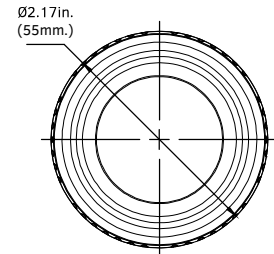
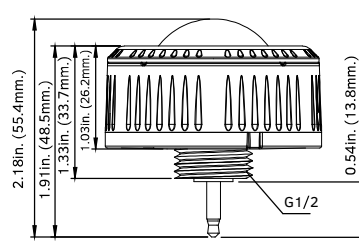

Specifications

- Power Supply:** 12V-24V DC, >30mA
- Dimming Control Output:** 0-10V, max. 25mA sinking current
- Remote Range:** 50ft. (15m) indoor, no backlight
- Detection Radius:** 20%/50%/75%/100% (1-8m)
- Mounting Height:** Max. 40'
- Time Setting:** 10s/1min/5min/10min/15min/20min/30min/60min
- Light Control:** 24H/10Lux/30Lux/50Lux
- Operating Temperature:** -4°F to 140°F (-20°C to 60°C)
- IP Rating:** IP65

Sensor Coverage

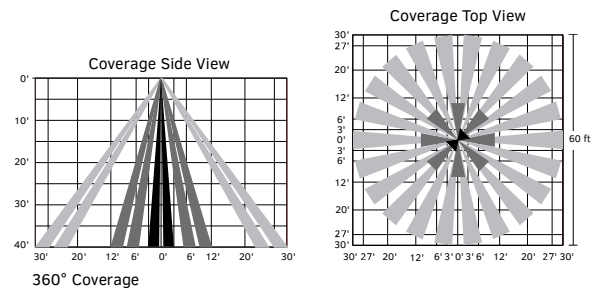

⚠ Important

- Sensor warm up time is 40 seconds. After the sensor connects to input power the first time, the light fixture will stay on for 40 seconds, then dim for normal operation.
- Factory Default Settings: Sensor Detection Range 100%, Sensor Hold Time 5 Minutes, Daylight Sensor ☀ (Corresponds to button on remote control used to turn the daylight sensor off), Stand-By Light Level 30%, Stand-By Time: 60 Minutes.
- When any setting is changed using the remote control, the light fixture that the sensor is connected to will turn on and off to confirm the change.

Multi-Level Function

The motion sensor includes the capability for tri-level control functionality, for areas which require a preliminary notification consisting of a change in the brightness of the light before the light switches off completely. When the sensor is installed, there are 3 lighting modes: 100% --> dimmed (under reduced natural lighting conditions) --> off, with 2 periods of selectable waiting time: sensor hold time and sensor stand-by time. Additional configurable options include light threshold for sensor operation, and sensor sensitivity/detection area.

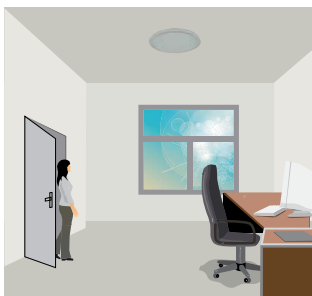

When natural lighting conditions are sufficient, the motion sensor does not turn on the fixture even when motion is detected.

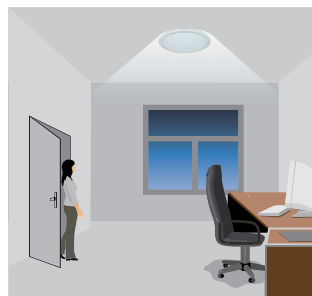

When natural lighting conditions fall below a selected threshold, the motion sensor turns on the fixture when motion is detected.

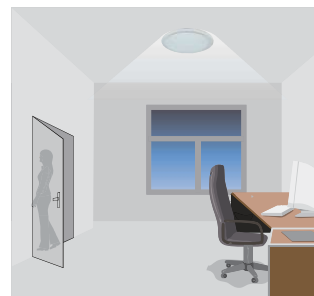

After sensor hold time elapses, the motion sensor dims the fixture to the stand-by light level if the natural light conditions are below the selected threshold.



After the stand-by time period elapses, the motion sensor switches the fixture off automatically.

Daylight Sensor Function

Select the daylight sensor function by pushing **(II)** when the remote control is in setting mode.

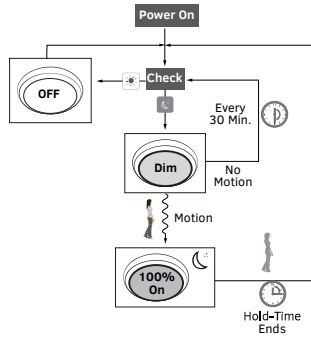

Settings In This Demonstration:

Hold-Time: 30 Minutes
 Setpoint On: 50 Lux
 Setpoint Off: 300 Lux
 Stand-By Dimming Level: 10%
 Stand-By Period: +∞

(The +∞ Stand-By Period option is only available when the Daylight Sensor is activated.)



When movement is detected, the light switches on to 100% brightness.

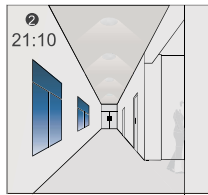

After sensor hold-time elapses, the light dims to the stand-by level.

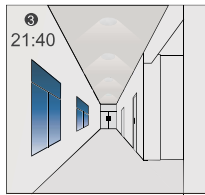

The light remains dimmed to the stand-by level at night.

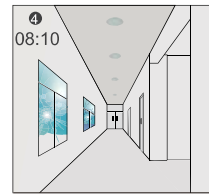
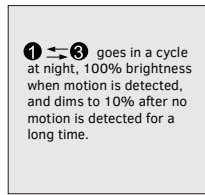

When the natural light level exceeds the "setpoint off" light level, the fixture will remain off even when the space is occupied.

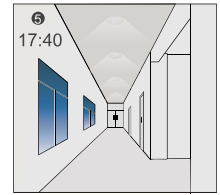

The light stays on at 10% brightness when motion is not detected and natural light conditions are insufficient.

Instructions for Sensor Parameter Adjustment Using Remote Are Included with the Remote

Motion Sensor Dip Switch Settings

Dip Switches are only available on BRI823 sensor for fixed wattage & CCT models

Dip Switch Factory Settings

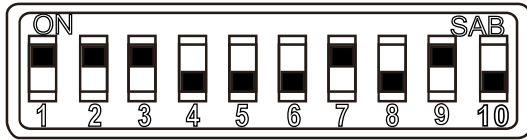
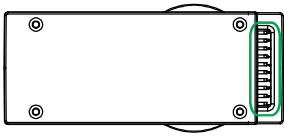

SENSOR DETECTION RANGE: 100% STAND-BY LIGHT LEVEL: 30%
 SENSOR HOLD TIME: 5 MINUTES STAND-BY TIME: 30 MINUTES
 LIGHT THRESHOLD: DISABLED

The operating parameters of the motion sensor may be adjusted directly from the sensor or remotely using an optional remote control. Adjustments made directly to the sensor are done using a set of dip switches on the sensor body, in the locations indicated in the above image.

Dip Switch Parameter Settings

Each motion sensor parameter may be adjusted by using a set of two adjacent dip switches. Dip switches 1 & 2 set sensor sensitivity, dip switches 3 & 4 set sensor hold time, dip switches 5 & 6 set the level of lux for sensor activation, dip switches 7 & 8 set sensor stand-by light level, and dip switches 9 & 10 set sensor stand-by time.

Dip Switch 1 & 2: Sensor Detection Range (Sensitivity) Settings

Sensor detection range, describes the radius of the circular detection zone on the ground below a sensor installed on a fixture (maximum ceiling height 40ft). To adjust sensor detection range, put the dip switches to either an ON position (↑) or an OFF position (↓) as indicated in the guide below.

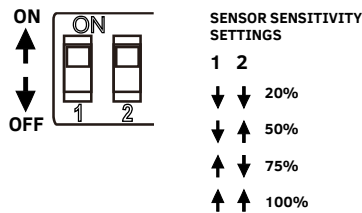

Dip Switch 3 & 4: Sensor Hold Time Settings

Upon detecting motion, the fixture light can be set to stay on for any period of time indicated in the options below. Any additional motion detected before the selected amount of time elapses will restart the timer. While adjusting the sensor detection zone and performing walk tests, it is recommended to select the shortest possible hold time. To adjust sensor hold time, put the dip switches to either an ON position (↑) or an OFF position (↓) as indicated in the guide below.

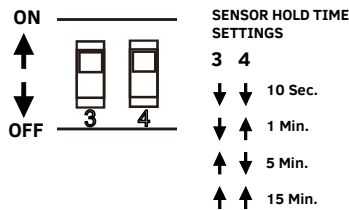

Dip Switch 5 & 6: Light Threshold Settings

The sensor light threshold indicates the ambient light level at which the sensor will begin to control the fixture. To adjust light threshold, put the dip switches to either an ON position (↑) or an OFF position (↓) as indicated in the guide below.

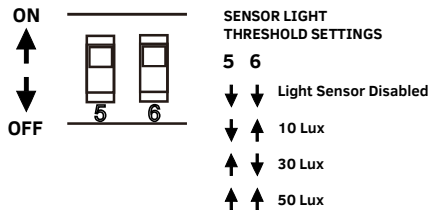

Dip Switch 7 & 8: Stand-By Light Level Settings

The stand-by light level determines the brightness of the fixture while the sensor is not detecting motion. To adjust stand-by light level, put the dip switches to either an ON position (↑) or an OFF position (↓) as indicated in the guide below.

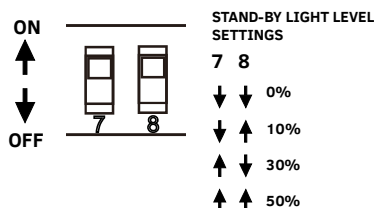

Dip Switch 9 & 10: Stand-By Time Settings

The stand-by time determines the length of time the fixture stays on while the sensor is not detecting motion. To adjust stand-by time, put the dip switches to either an ON position (↑) or an OFF position (↓) as indicated in the guide below.

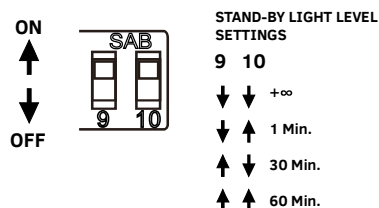

Instructions for Sensor Parameter Adjustment Using Remote Are Included with the Remote